

7 DEALER MANUAL FOR DP E160.CAN

DEALER MANUAL FOR DISPLAY



CONTENT

7.1 Important Notice	2	7.7 Normal Operation	5
7.2 Introduction of Display	2	7.7.1 Switching the System ON/OFF.....	5
7.3 Product Description	3	7.7.2 Selection of Support Levels.....	5
7.3.1 Specifications.....	3	7.7.3 Headlights / backlighting.....	5
7.3.2 Functions Overview.....	3	7.7.4 Walk Assistance.....	5
7.4 Display Installation	3	7.7.5 Battery Capacity Indication.....	6
7.5 Display	4	7.8 Error Code Definition	7
7.6 Key Definition	4		

7.1 IMPORTANT NOTICE

- If the error information from the display cannot be corrected according to the instructions, please contact your retailer.
- The product is designed to be waterproof. It is highly recommended to avoid submerging the display under water.
- Do not clean the display with a steam jet, high-pressure cleaner or water hose.
- Please use this product with care.
- Do not use thinners or other solvents to clean the display. Such substances can damage the surfaces.
- Warranty is not included due to wear and normal use and aging.

7.2 INTRODUCTION OF DISPLAY

- Model: DP E160.CAN BUS
- The housing material is PC+ABS and acrylic, as following:



- The label marking is as follows:



- i** **Note:** Please keep the QR code label attached to the display cable. The information from the Label is used for a later possible software update.

7.3 PRODUCT DESCRIPTION

7.3.1 Specifications

- Operating temperature: -20 °C~45 °C
- Storage temperature: -20 °C~50 °C
- Waterproof: IP65
- Storage room Humidity: 30%-70% RH

7.3.2 Functional Overview

- Battery capacity indicator
- Indication of support level
- Walk assistance
- Automatic sensors explanation of the lighting system
- Indication for error messages
- Control and indication of lighting system

7.4 DISPLAY INSTALLATION

1. Open the clamp A on the display and place the display on to the handlebar in the correct position, where it is suitable for operation (the applicable handlebar are $\varnothing 22.2\text{mm}$).

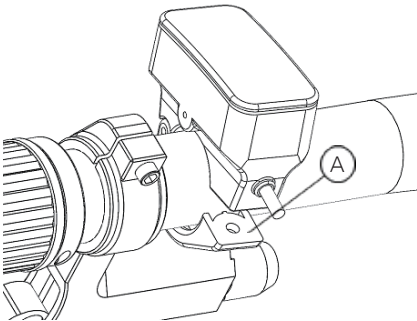

2. With the screw B (M3*10 hexagon socket screw) tighten the display into position, torque requirement: 1N.m.

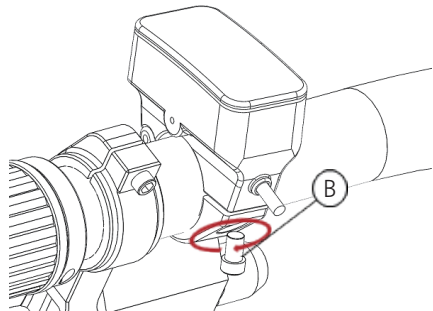

3. Please link the display to the EB-BUS cable.
h: male connector at the display.
H: female connector at the EB-BUS.

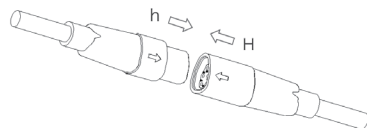

7.5 DISPLAY

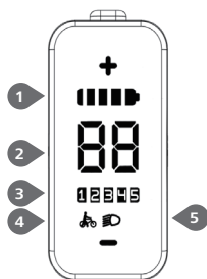

- 1 Battery capacity indicator
- 2 Speed indicator
- 3 Support level indicator
- 4 Walk assistance
- 5 Indicator for lighting system

7.6 KEY DEFINITION

E160 Display has three buttons: System On/Off  , Up  and Down  .

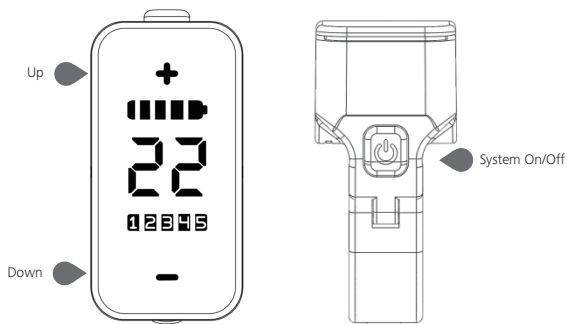

7.7 NORMAL OPERATION



7.7.1 Switching the System ON/OFF

Press and hold  (>2S) on the display to turn on the system.

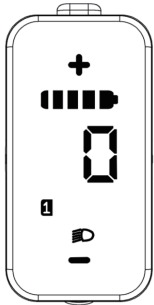
Press and hold  (>2S) again to turn off the system.



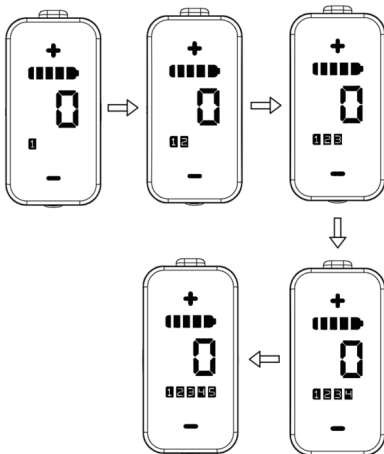

7.7.2 Selection of Support Levels

When the display is turned on, press the  or  (<0.5S) button to switch to the support level, the lowest level is 1, the highest level is 5. When the system is switched on, the support level starts in level 1. There is no support at level 0.





7.7.3 Headlights / backlighting

Hold the  (>2S) button to activate the headlight and taillights.

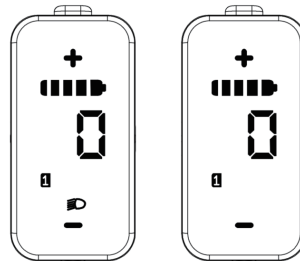
Hold the  (>2S) button again to turn off the headlight and taillight. (If the display is turned on in a dark environment, the display backlight/headlight will be turned on automatically. If the display backlight/headlight are turned off manually, they also need to be turned on manually afterwards)







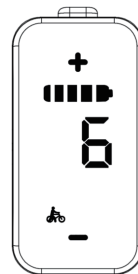

7.7.4 Walk Assistance

When your Pedelec is motionless, briefly press  button until the Walk assistance indicator  is displayed. At this point, long press  button, the Pedelec enters the walk assistance mode, the indicator will flash. If release the button will stop this, if no any operations within 5s will automatically return to 0 level. That is stopped from the Walk assistance mode.(as following)



7.7.5 Battery Capacity Indication

The battery capacity is indicated with 5 levels. When the lowest level indicator flashes that means battery needs to charge. The battery capacity is shown as follows:

Indication definition	SOC	Example
5 bars	80%-100%	
4 bars	60%-80%	
3 bars	40%-60%	
2 bars	20%-40%	
1 bar	5%-20%	
1 flashing	<5%	

7.8 ERROR CODE DEFINITION



DP E160.CAN display can provide warning for failures. The error code flickers when an error is detected.

Note: please read carefully the description of the error code. When the error code appears, please first restart the system. If the problem is not eliminated, please contact your dealer or technical personnel.



Error	Declaration	Troubleshooting
04	The throttle has fault.	<ol style="list-style-type: none"> 1. Check the connector and cable of the throttle are not damaged and correctly connected. 2. Disconnect and reconnect the throttle, if still no function please change the throttle.
05	The throttle is not back in its correct position.	Check the connector from the throttle is correctly connected. If this does not solve the problem, please change the throttle.
07	Overvoltage protection	<ol style="list-style-type: none"> 1. Remove and re-Insert the battery to see if it resolves the problem. 2. Using the BESST tool update the controller. 3. Change the battery to resolve the problem.
08	Error with the hall sensor signal inside the motor	<ol style="list-style-type: none"> 1. Check all connectors from the motor are correctly connected. 2. If the problem still occurs, please change the motor.
09	Error with the Engine phase's	Please change the motor.
10	The temperature inside the engine has reached its maximum protection value	<ol style="list-style-type: none"> 1. Turn off the system and allow the Pedelec to cool down. 2. If the problem still occurs, please change the motor.
11	The temperature sensor inside the motor has an error	Please change the motor.
12	Error with the current sensor in the controller	Please change the controller or contact your supplier.

Error	Declaration	Troubleshooting
13	Error with the temperature sensor inside of the battery	<ol style="list-style-type: none"> 1. Check all connectors from the battery are correctly connected to the motor. 2. If the problem still occurs, please change the Battery.
14	The protection temperature inside the controller has reached its maximum protection value	<ol style="list-style-type: none"> 1. Allow the pedelec to cool down and restart the system. 2. If the problem still occurs, please change the controller or contact your supplier.
15	Error with the temperature sensor inside the controller	<ol style="list-style-type: none"> 1. Allow the pedelec to cool down and restart the system. 2. If the problem still occurs, Please change the controller or contact your supplier.
21	Speed sensor Error	<ol style="list-style-type: none"> 1. Restart the system 2. Check that the magnet attached to the spoke is aligned with the speed sensor and that the distance is between 10 mm and 20 mm. 3. Check that the speed sensor connector is connected correctly. 4. Connect the pedelec to BESST, to see if there is a signal from the speed sensor. 5. Using the BESST Tool- update the controller to see if it resolves the problem. 6. Change the speed sensor to see if this eliminates the problem. If the problem still occurs, please change the controller or contact your supplier.
25	Torque signal Error	<ol style="list-style-type: none"> 1. Check that all connections are connected correctly. 2. Please connect the pedelec to the BESST system to see if torque can be read by the BESST tool. 3. Using the BESST Tool update the controller to see if it resolves the problem, if not please change the torque sensor or contact your supplier.

Error	Declaration	Troubleshooting
26	Speed signal of the torque sensor has an error	<ol style="list-style-type: none"> 1. Check that all connections are connected correctly. 2. Please connect the pedelec to the BESST system to see if speed signal can be read by the BESST tool. 3. Change the Display to see if the problem is solved. 4. Using the BESST Tool update the controller to see if it resolves the problem, if not please change the torque sensor or contact your supplier.
27	Overcurrent from controller	Using the BESST tool update the controller. If the problem still occurs, please change the controller or contact your supplier.
30	Communication problem	<ol style="list-style-type: none"> 1. Check all connections on the pedelec are correctly connected. 2. Using the BESST Tool run a diagnostics test, to see if it can pinpoint the problem. 3. Change the display to see if the problem is solved. 4. Change the EB-BUS cable to see if it resolves the problem. 5. Using the BESST tool, re-update the controller software. If the problem still occurs please change the controller or contact your supplier.
33	Brake signal has an error (If brake sensors are fitted)	<ol style="list-style-type: none"> 1. Check all connectors are correctly connected on the brakes. 2. Change the brakes to see if the problem is solved. <p>If problem continues Please change the controller or contact your supplier.</p>
35	Detection circuit for 15V has an error	Using the BESST tool update the controller to see if this resolves the problem. If not, please change the controller or contact your supplier.
36	Detection circuit on the keypad has an error	Using the BESST tool update the controller to see if this resolves the problem. If not, please change the controller or contact your supplier.

Error	Declaration	Troubleshooting
37	WDT circuit is faulty	Using the BESST tool update the controller to see if this resolves the problem. If not, please change the controller or contact your supplier.
41	Total voltage from the battery is too high	Please change the battery.
42	Total voltage from the battery is too low	Please Charge the battery. If the problem still occurs, please change the battery.
43	Total power from the battery cells is too high	Please change the battery.
44	Voltage of the single cell is too high	Please change the battery.
45	Temperature from the battery is too high	Please let the pedelec cool down. If problem still occurs, please change the battery.
46	The temperature of the battery is too low	Please bring the battery to room temperature. If the problem still occurs, please change the battery.
47	SOC of the battery is too high	Please change the battery.
48	SOC of the battery is too low	Please change the battery.
61	Switching detection defect	1. Check the gear shifter is not jammed. 2. Please change the gear shifter.
62	Electronic derailleur cannot release.	Please change the derailleur.
71	Electronic lock is jammed	1. Using the BESST tool update the Display to see if it resolves the problem. 2. Change the display if the problem still occurs, please change the electronic lock.
81	Bluetooth module has an error	Using the BESST tool, re-update the software onto the display to see if it resolves the problem. If not, Please change the display.